

WELMEC 2.4
(Issue 2)

WELMEC

European cooperation in legal metrology

GUIDE FOR LOAD CELLS



August 2001

WELMEC

European cooperation in legal metrology

WELMEC is a cooperation between the legal metrology authorities of the Member States of the European Union and EFTA. This document is one of a number of Guides published by WELMEC to provide guidance to manufacturers of measuring instruments and to notified bodies responsible for conformity assessment of their products. The Guides are purely advisory and do not themselves impose any restrictions or additional technical requirements beyond those contained in relevant EC Directives. Alternative approaches may be acceptable, but the guidance provided in this document represents the considered view of WELMEC as to the best practice to be followed.

Published by:
WELMEC Secretariat
NWML
Stanton Avenue
Teddington
TW11 0JZ
United Kingdom

Tel: +44 20 8943 7216
Fax: +44 20 8943 7270
E-mail: welmec@nwml.gov.uk
Website: www.welmec.org

Table of Contents

Introduction	2
Part A : General acceptance of load cells and load receptors in type approvals of weighing instruments	4
A.1 General acceptance of load cells (LCs)	4
A.2 Standard load transmission devices	6
A.3 Common load receptors	7
A.3.1 Acceptable solutions	7
A.3.2 Examples	11
A.4 Documentation	13
A.5 Wording in type approval certificates (TAC)	13
Part B : Testing and certification of load cells and load cell families	14
B.1 Metrological and practical aspects	14
B.1.1 Test procedures	14
B.1.2 LC series and families, selection of samples	16
B.2 Documentation	16
B.3 Test report	16
B.4 Test certificate (TC)	17
B.4.1 Layout of the test certificate	17
B.4.2 Contents of the annex of the TC	18
B.4.3 Revision of existing TCs	19

INTRODUCTION

Weighing instruments (WIs) are often constructed from typical modules such as indicator, mechanical construction and load cell. Therefore, type examinations are often performed on representative modules which can be tested separately.

For non-automatic weighing instruments (NAWIs) the basis of this modular concept is laid down in OIML R 76, No 8.2, and EN 45501, No 8.1, respectively, where the following relevant cases are mentioned:

- testing of the instrument as a whole is difficult or impossible
- the module is manufactured and/or placed on the market as a separate unit to be incorporated in a complete instrument
- the applicant wants to have a variety of modules included in the approved pattern.

Until now, type approval certificates (TAC) of Weighing instruments have explicitly mentioned the allowed modules and combinations, respectively. Especially for load cells (LC), this leads to growing lists in TACs, containing LCs of different constructions, capacities and metrological characteristics, together with references to drawings of mechanical constructions, ie of load receptors and load transmissions.

Over the last few years, the problem of expanding load cell tables in TACs of weighing instruments and the necessity for a general acceptance of LCs has been discussed within WG2. As a consequence, in November 1995 the work of the WG2 subgroup (SG) was extended to include the problems of load cells and to work out a guide to harmonize testing and certification of LCs in the context of type approvals of non-automatic weighing instruments under Directive 90/384/EEC.

This guide is also intended to cover LCs for automatic weighing instruments (AWIs) as far as their static behaviour is concerned. In general, LCs for AWIs require additional tests, eg dynamic tests, which are not treated in this guide.

The following guide tries to cover two main aspects related to the module "load cell" which are treated in two separate parts:

Part A deals with the general acceptance of LCs in TACs, enabling LCs with a test certificate to be freely used in approved weighing instruments, without formal amendments to existing type approvals. This part provides the prerequisites and rules according to which load cells, including the necessary mechanical elements, as load transmission and load receptors, can be generally accepted in type approvals of weighing instruments. Part A thus is primarily directed at manufacturers of weighing instruments who are interested in type approval certificates (TAC) which provide maximum flexibility with respect to LCs and load receptors.

Part B contains practical aspects of LC testing as well as the necessary information which has to be provided in test certificates of LCs. It is primarily directed at manufacturers of LCs who are interested in test certificates.

It is evident that LCs, as modules of WIs require harmonized test procedures and a common level of information provided in test certificates. Therefore, and although the new OIML recommendation R60 for load cells has been issued in 2000, part B, gives some additional information concerning test procedures and other relevant aspects in order to further harmonize testing and certification of LCs and LC families by the various European Notified Bodies.

Of course, this new general concept for the module “load cell“ does not only concern the Notified Bodies responsible for type examination of Weighing instruments and testing of LCs, but also those who are responsible for the verification of new or repaired weighing instruments.

Part A :

General acceptance of load cells and load receptors in type approvals of weighing instruments

A.1 General acceptance of LCs

Until now, the usual practice with type approvals of weighing instruments has been to include in a TAC load cell tables which explicitly mention the permitted load cell types, manufacturers, test certificates, detailed drawings of load transmissions (force introductions) and references to drawings of load receptors. The disadvantage of this practice is that the existing load cell tables have to be supplemented each time a new load cell type is added.

In order to offer both Notified Bodies and manufacturers more flexibility, the general acceptance of load cells and the necessary prerequisites and rules are presented in this chapter. To avoid misunderstandings, it should be noted that a manufacturer is free to choose the “conventional” LC tables in the usual manner, or to choose both the special LC tables and the general statement in a TAC.

On the other hand, where it was deemed necessary a Notified Body may perform additional tests to check conformity to the Essential Requirements of certain combinations of modules making up a complete instrument. This is in line with Annex II 1.2 of EC Directive 90/384 and it is the decision of the Notified Body to choose the most critical version.

In either case, the requirements of WELMEC2 (Issue 3, 2000) section 11, concerning the compatibility of modules should be observed.

Until further experience has been gained, the general acceptance of LCs is restricted to well-identified and “non-critical” types of weighing instruments, such as weighbridges, platform scales, hopper scales, crane scales and overhead track scales, with or without lever systems.

It shall, for example, not be applied to weighing instruments built in trucks or to movable pallet weighers.

Table 1 gives an overview of:

- the types of load receptor construction/design for which load cells may be generally used,
- the acceptable designs of load transmission devices suitable for the different LC types, as identified by Table 2 and Table 3,
- the types of LC that can be suitable for the different load receptor types, as identified by Table 4.

Neither Table 1 nor Tables 2 to 4 need to be included in a TAC, because the general statement in the TAC (see A.5) makes reference to the examples given in this WELMEC document.

Table 1:

Types of NAWIs regarded as being "non-critical"; for NAWIs covered by this table a general statement according to A.5 may be given in the TAC.





Type of NAWI	Load receptor		Load Cell	
	Type		Type	load transmission
scales with lever system				
	all load receptors with lever system according to No. 6.3 EN 45 501		{ compression tension beam	co- 1-7-8 te- 1-2 be- 1-4-5-6
scales without lever system				
weighbridge	1 or more platforms	<i>in floor</i>	{ compression tension beam double ended beam	co- 2-3-4-5-6 te- 1-2 be- 2-3-7-8-9-10-11 de- 1-2-3
	multiple platform with joint	<i>over floor</i> <i>in floor</i> <i>over floor</i>		
platform scale	1 or more platforms	<i>in floor</i>	{ compression " tension beam double ended beam	co- 2-3-4-5-6 co- 7-8 te- 1-2 be- 1-2-3-4-5-6-7-8 9-10-11 de- 1-2-3
	multiple platform with joint	<i>over floor</i> <i>in floor</i> <i>over floor</i>		
	platform	maximum dimensions if necessary	single point	direct
hopper scale	hopper suspended hopper supported		{ compression " tension beam double ended beam	co- 2-3-4-5-6 co- 7-8 te- 1-2 be- 1-2-3-4-5-6-7-8 9-10-11 de- 1-2-3
	hopper, by unsymmetric loading			single point
	maximum dimensions if necessary			
crane scale	crab double crab hoist		{ compression tension beam double ended beam	co- 2-3-4-5-6 te- 1-2 be- 2-3-7-8-10-11 de- 1-2-3
	hook			{ compression tension beam
overhead track scale	rail	(for combinations with platforms see „platform scale“)	{ tension beam	te- 1-2 be- 1-2-3-4-5-6-7-8 9-10-11
	rail	maximum linear length if necessary		single point

Abbreviations used:

- co compression load cell
- te tension load cell
- be beam load cell, either double bending or shear beam, but not single bending beam
- sp single point load cell
- de double ended beam load cell

A.2 Standard load transmission devices

Tables 2 and 3 identify different types of LCs, (compression, tension, ...) and typical load cell mounting devices suitable for them. The symbols below classify the mobility between one point of contact on the load cell and its counterpart on the load receptor or mounting base.

Symbol	Description
	Movement possible normal to load axis Note: allows for temperature dilatation
	Movement possible normal to load axis, with reversing force (spring-back effect) Note: allows for temperature dilatation, also used for damping of lateral shock
	Inclination possible Note: allows for tilt of load cell or deflection of load receptor, no movement normal to load axis possible
	Indicates auto-centering effect of the complete mounting assembly of one load cell

Remarks on the standard load transmission devices presented in Tables 2 and 3 :

All combinations of load cell and transmitting device shown in Tables 2 and 3 can also be utilised in a completely reversed manner.

The load transmission device is independent of the encapsulation, potting or housing which are shown in the examples.

(a) Compression LCs (Table 2, upper part)

- The load transmissions 1 to 8 are presented for canister type LCs. Instead, all load transmissions may be constructed for S-type or ring-type load cells.
- 6a shows a pendulum construction built as a complete unit.
- 6b and 6c show external pendulum rocker pins combined with ring-type LCs.
- The bearings for all compression load cells may be installed either below or above the LC.

(b) Tension LCs (Table 2, lower part)

- The load transmissions 1 and 2 are presented for canister type LCs. Alternatively, both load transmissions may be used for S-type LCs.

(c) Beam LCs (Table 3, upper part)

- The drawings present double bending and shear beams , as well as plastic potted and encapsulated constructions; all these constructions may be combined with either of the load transmissions 1 to 10.

- The direction of loading, which is given by the manufacturer, has to be observed.

(d) Single point LCs (Table 3, middle part)

- The load transmissions 1 to 10 for the beam LCs may be applied to all single point LCs.
- The direction of loading, which is given by the manufacturer, has to be observed.

(e) Double ended beam LCs (Table 3, lower part)

The table shows examples of common constructions. Variations are possible provided the constructions allow enough horizontal flexibility between both ends.

- The direction of loading, provided by the manufacturer, has to be observed.

The single bending beams had been exempted for general acceptance, because very small displacements of the “force transducing point“ may lead to a change of span and linearity.

A.3 Common load receptors

As previously mentioned, it is the aim of the new concept to reduce the necessary LC information provided in individual TACs by making reference to general rules and principles which are treated in this guide.

According to this concept, common load receptors (LR) need no longer be explicitly mentioned or described in the TAC of a weighing instrument if:

- the following generally acknowledged principles and requirements (sections A.3.1 and A.3.2) are observed, and
- the LCs (technical data, dimensions, manufacturer) are identical in the case that more than one LC is incorporated in the LR, and
- the suitability of a LR construction is checked at the time of EC declaration of type conformity or at EC verification according to EN 45501, No. 8.2, especially the metrological tests according to No. 8.2.2.

Other (special) LR constructions not being covered by these general regulations may, of course, be chosen by the manufacturer. These constructions shall then be described in the TAC with reference to their respective drawing number.

A.3.1 Acceptable solutions

If the following general requirements are met, a LR construction can then be regarded as a common type. In case of doubt, the Notified Body responsible for the type approval should be consulted.

In case of LRs with levers EN 45501 No. 6.3.2 shall be observed.

- **Weighbridges, platform scales**

- Load receptors liable to be tilted must meet requirement EN45501, No. 3.9.1 .
- Foundations for outdoor instruments

Weighbridges fixed firmly on the ground shall be mounted on stable foundations. The depth of the foundations shall be below the frost line. Over floor weighbridges without proper foundations shall be constructed in a manner that any changes of the soil under the LR (ie by freezing) do not effect the correct function of the weighing instrument.

- Cleaning and drainage for outdoor instruments

The space between weighbridge and ground shall allow all covered parts of the LR to be kept clean. LRs mounted in a pit or a trough as well as LRs with shafts or manholes under the cover which might be filled with water have to be kept dry by a drainage system. Moreover the soil under the bridge shall be surfaced (eg paved).

- Inspection of leverwork and / or LCs

Leverwork, load cells, junction boxes and stays shall be easy to inspect without any extraordinary difficulty or danger. Hence the cover of the load receptor shall be easily removable or has a type of lid or trap door allowing an inspection of the parts under the cover.

- If a combination of several load receptors is used and only the total weight can be indicated, the maximum load of a single LR should be chosen in the sense of EN 45501 No. 3.6.2 to prevent undetected overloading of one LR.
- There should be an appropriate device to protect the LC and the LR against too large horizontal displacements of the LR.
- The construction of the LR must take into account the effects of flexion and guidance of the LR, which is tested with excentric loading at the initial verification.

- **Crane scales**

- For crab and hoist constructions:
 Traverse tests in all directions shall be conducted instead of eccentricity tests.
- While the load applied is in movement either no weighing shall be possible or special steps shall be taken in order to meet the requirements of EN 45501, especially No. 4.4.2 (stable equilibrium).

- **Outdoor scales in general**

- Outdoor instruments must be constructed in such a manner that their metrological behaviour is not inadmissibly influenced by climate factors, eg wind, rain, temperature gradients (solar radiation, or perhaps by putting the instrument from indoor to outdoor in service).

Table 2: Schematic drawings for compression and tension LCs

Load cell construction and load transmission device			
Basic construction principles for compression or tension	 <p>canister type (co, te)</p>	 <p>S-type (co, te)</p>	 <p>ring type (co)</p>
			needs a stiff base plate
Compression LC			
load transmissions shown for canister type, also possible for S-type and ring type			
 <p>① half pendulum</p>	 <p>② multiple ball bearing</p>	 <p>③ ball support</p>	 <p>④ low friction surfaces e.g. PTFE</p>
 <p>⑤ low horizontal spring rate, eg elastomer</p>	 <p>⑥ pendulum (kit)</p>	 <p>⑥a original pendulum construction</p>	 <p>⑥b ring type pendulum applications</p>
 <p>⑦ tens. modif. 1 side joint</p>	 <p>⑧ tens. modif. 2 side joints</p>		
Tension LC			
shown for canister type, also suitable for S-type			
 <p>① 1 side joint</p>	 <p>② 2 side joints</p>	<p>further elements for all tension constructions for joints:</p> <p>hook, rope wire, flexure strips</p>	

Table 3: Schematic drawings for beam LCs

Load cell construction and load transmission device

The load transmission device is independent of the encapsulation, potting or housing and the mounting at the fixed end shown below

Beam LC - Cantilever beam

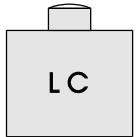
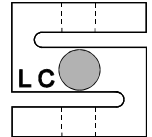
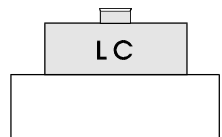
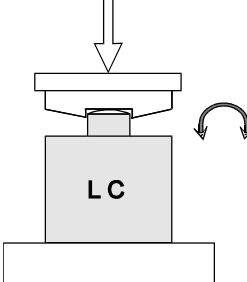
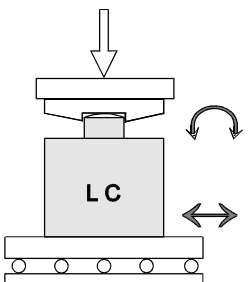
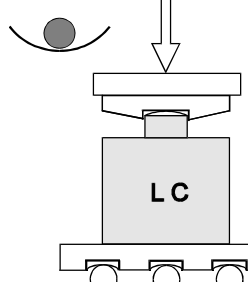
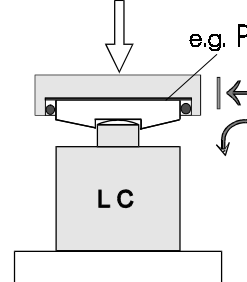
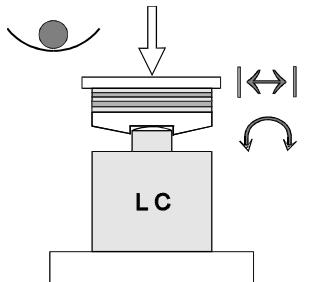
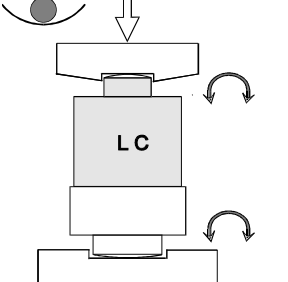
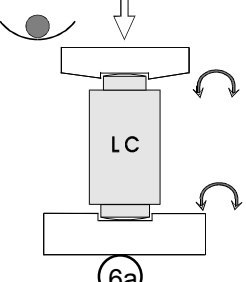
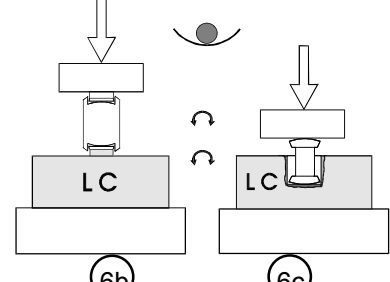
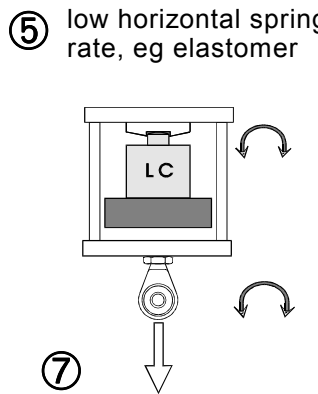
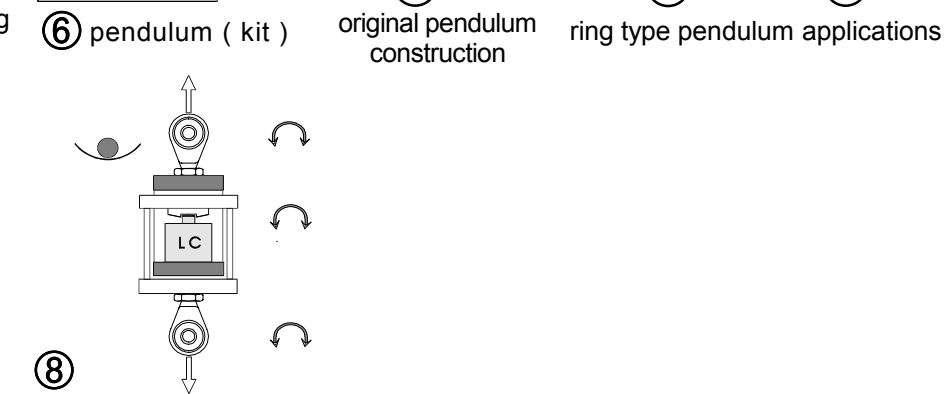
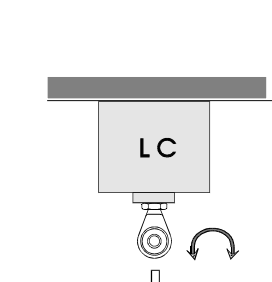
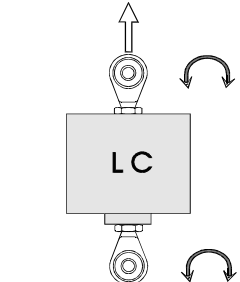
Double bending beam & Shear beam LC

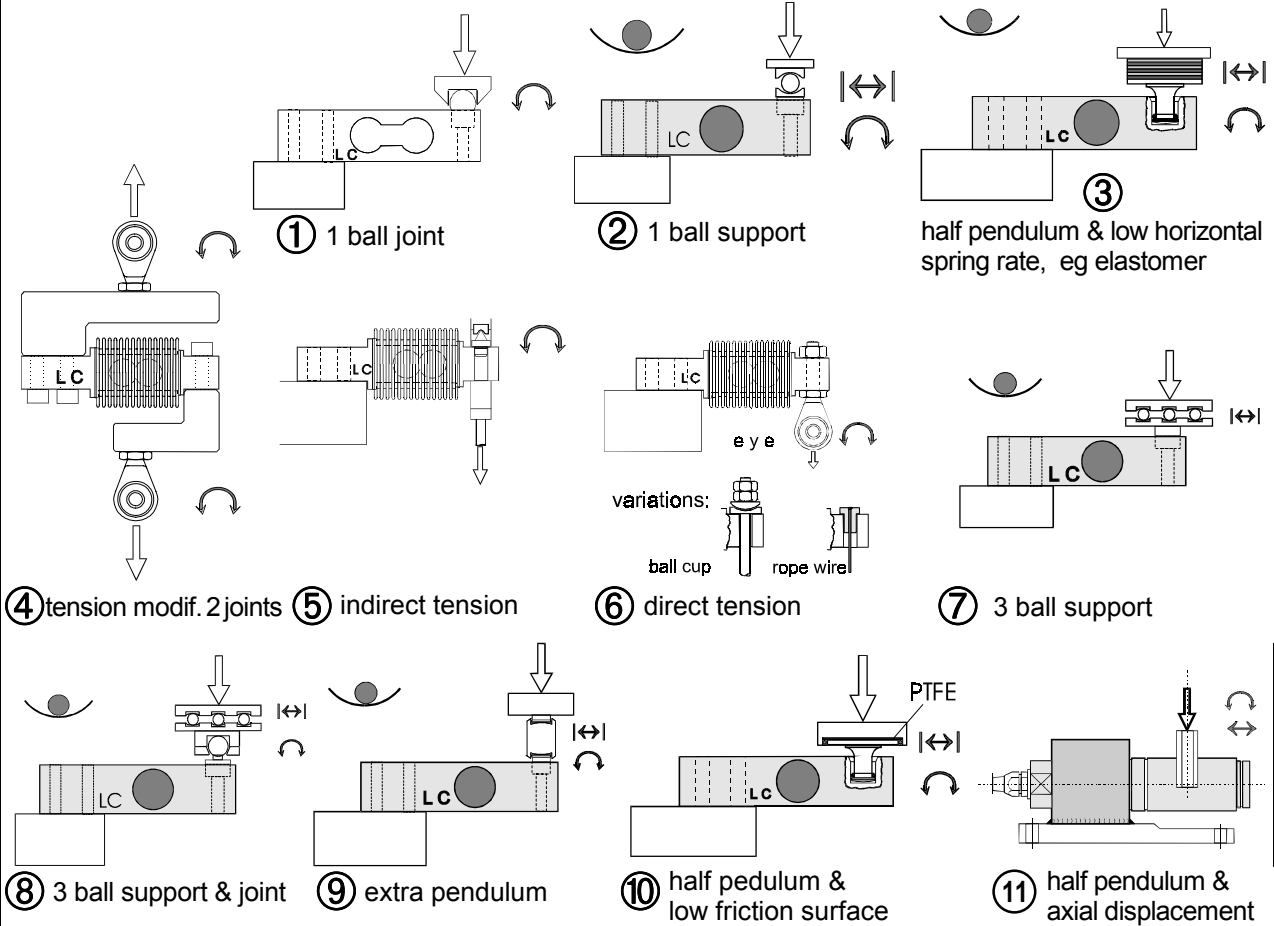

Single point LC

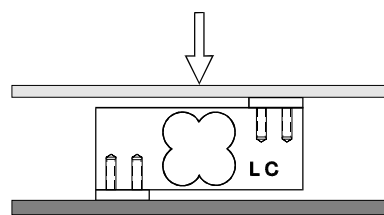

The single point LC has no degree of freedom for horizontal displacement or inclination, using more than one LC in a load receptor decoupling elements are necessary.

The load transmissions 1 to 10 for the beam LCs may be applied.

Max. platform dimensions may be mentioned in the TC or the TAC.

Double ended beam LC

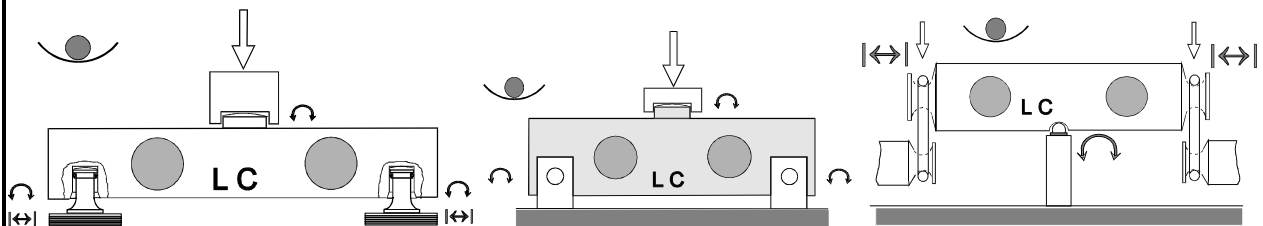

Constructions with fixed clamping at the two ends need for minimum displacement and inclination some elasticity of the supporting construction.

A.3.2 Examples

In the following, some examples of acceptable solutions of LRs are given which are regarded as common types. The list does not claim to be complete and other solutions can be accepted as common types provided they meet the general requirements listed in section A.3.1. The examples shown in Table 4 need not be mentioned in the TAC of a weighing instrument.

Table 4:

Examples of LRs considered as being common and non-critical

in floor

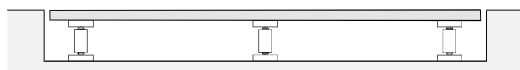
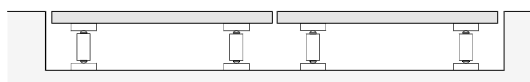
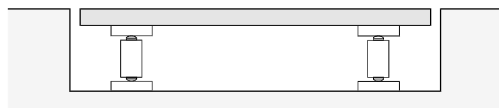

over floor

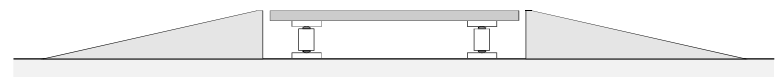
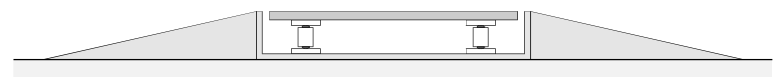
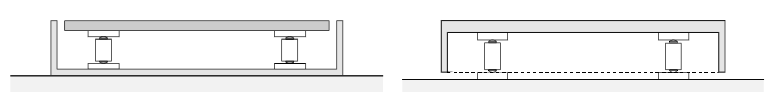

double platform with joint

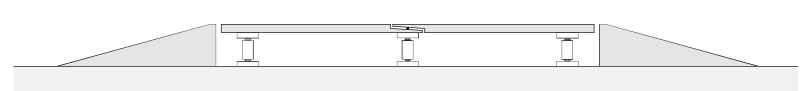
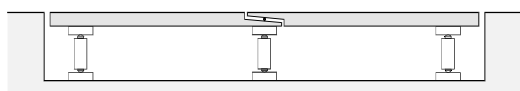

hopper suspended

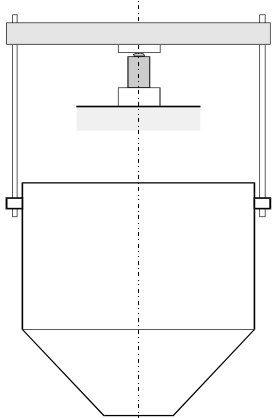

hopper supported

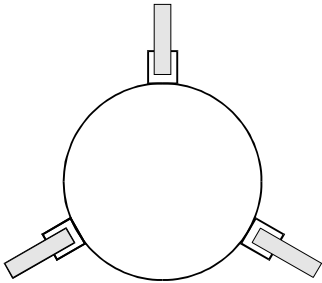
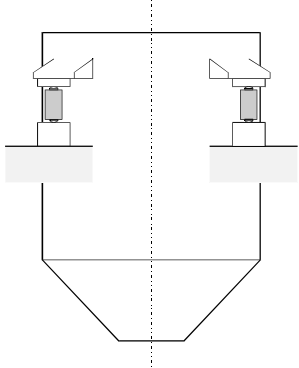
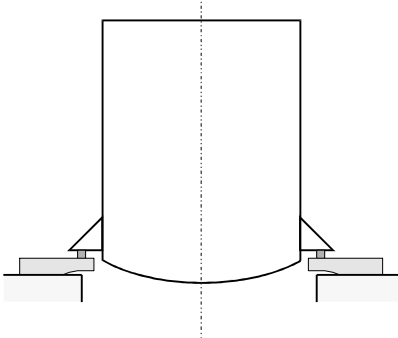

crab

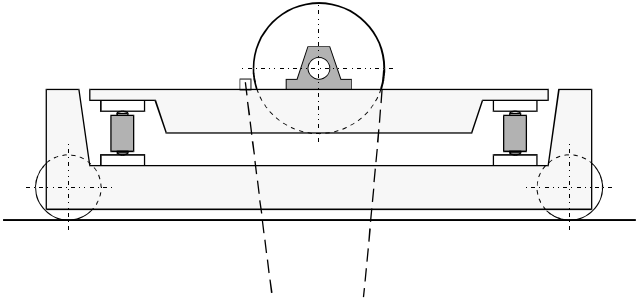

hook

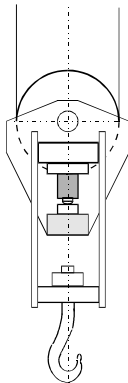

hoist

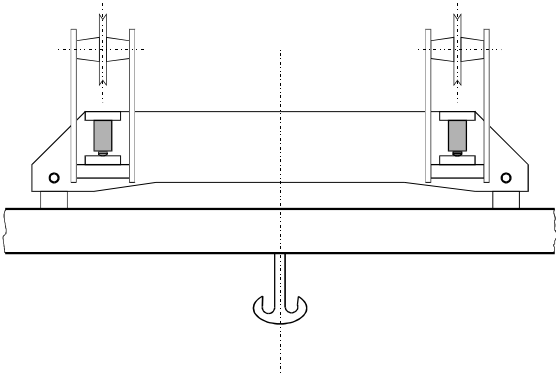

A.4 Documentation

To be supplied to the Notified Body by the applicant for a TAC (NAWI)

- In the case that only the general statement according to A.5 is requested and both, the load receptors and the load transmissions, are in accordance with the standard solutions given in A.2 and A.3 of this guide, no documentation with regard to load receptors, load transmissions and load cells need to be supplied.
- In the case of a manufacturer of a NAWI that chooses a special solution for a load receptor, a load transmission or a load cell, this has to be documented in the usual manner.

A.5 Wording in the TAC

As mentioned above, the manufacturer can choose between either the special LC tables in the TAC in the usual manner, or the general acceptance of LCs, or both.

In the case of general acceptance, it is also possible that only certain types of NAWIs, as listed in Table 1 (eg weighbridge), can be stated in the TAC at the request of the manufacturer.

In the case of **general acceptance**, the TAC of the NAWI must contain the following **general statement**:

“Any load cell(s) may be used for instruments under this TAC, provided the following conditions are met:

- 1) There is a respective test certificate (EN 45501) or an OIML Certificate of Conformity (R60 (1991 or 2000)) issued for the load cell by a Notified Body responsible for type examination under Directive 90/384/EEC.
- 2) The certificate contains the load cell types and the necessary load cell data required for the manufacturer’s declaration of compatibility of modules (WELMEC 2, Issue 3, 2000, No. 11), and any particular installation requirements¹). A load cell marked **NH** is allowed only if humidity testing to EN 45501 has been conducted on this load cell. ²)
- 3) The compatibility of load cells and indicator is established by the manufacturer by means of the compatibility of modules form, contained in the above WELMEC 2 document, at the time of EC verification or declaration of EC conformity of type.
- 4) The load transmission must conform to one of the examples shown in the WELMEC Guide for load cells. “

Notes (not to be included in the TAC):

¹ If necessary former LC-TCs should be revised according to the general acceptance so that they contain eg all relevant LC data, except for the examples given in B.4.3 .

² The latter condition does not mean a restriction with regard to decision WELMEC WG2/11/4 of 7 November 1995 which allows an NH marked LC to be tested also within the housing of a complete instrument. The free use of modules requires the respective LC to be humidity tested **independently of the housing**. Nevertheless, a LC being humidity tested **within a housing** may also be included in a TAC and used for the modular construction route, provided the combined LC/housing is mentioned explicitly in the TAC and treated as **one** module.

Part B :

Testing and certification of load cells and load cell families

LC tests shall always be conducted according to OIML R60 (2000).

For revision of existing TCs based on OIML R60 (1991) see section B.4.3.

This part is intended to give some additional information concerning test procedures, documentation and test certificates in order to further harmonize testing and certification of LCs and LC families by the various European Notified Bodies.

B.1 Metrological and practical aspects

B.1.1 Test procedures

a) Fraction p_{LC}

The fraction p_{LC} is dealt with in OIML R60 (2000), No. 5.1.

Additional remarks:

The chosen fraction p_{LC} is applied to the maximum permissible error (mpe) and to the minimum dead load output (MDLO).

Weighing modules (= digitally working “weighing instruments“, including mechanical structures, but without a display, output adjusted in units of mass) are a special case. They may be tested with $p_{LC} = 1,0$ if no further modules contribute to the mpe of the complete instrument. LCs with an arbitrary digital output are not considered to be weighing modules, they can be tested with $0,3 \leq p_{LC} \leq 0,8$ only.

b) Creep and DR

Creep and DR are dealt with in OIML R60 (2000), No. 5.3.

Additional remarks:

The time and output signal should be registered carefully, because the time is an essential quantity for a sufficient accurate evaluation. The recommended way is a continuous automatic or semi-automatic data registration. Manual registration should be avoided because it usually leads to non-uniform test results if tests are repeated or performed by different test laboratories. This means also that Form D.5 of OIML R60 (2000) for Creep and DR cannot be used as it is, but should be extended.

c) Humidity effects

Humidity effects are dealt with in OIML R60 (2000), No. 5.5.3.

Additional remarks:

LCs with NH marking which have been tested to EN 45501 B.2.2 **within their housing** may be mentioned in a TAC (load cell and description of the housing), but these load cells cannot be used freely (ie without the respective housing) for weighing instruments with a TAC containing the statement regarding the general acceptance of load cells only (see section A.5).

LCs without NH marking and LCs with SH or CH marking can be used without any limitation for general acceptance according to Part A.

d) Additional tests for LCs equipped with electronics

Additional tests for LCs equipped with electronics are dealt with in OIML R60 (2000), No. 6.

Additional remarks:

- 1 Electromagnetic susceptibility (6.3.5; A.4.7.7):
 - Attention should be paid to parameters of electronic filters of the sample and applied hold-up time of the interference for each frequency.
 - Applying of the necessary loads for switching off the zero tracking device is difficult especially for high capacity load cells. In these cases, it must be possible to switch off the automatic zero tracking device by other means.
 - According to the regulation Table D.16.1 a load cell has to be tested in the electromagnetic field in four directions. Although a load cell may be hermetically metallic encapsulated there may be a dependence due to direction of the electromagnetic field often caused by the cable entrance.

- 2 Warm-up time (6.3.2; A.4.7.2)
 - For high capacity load cells the initial measurement (first column of Form D11 in R60(2000)) often requires a loading time of several minutes so that no value can be entered for the time "0". In this case the report should contain a respective short remark.

- 3 Span stability and warm-up time (6.3.2 & 6.3.6; A.4.7.2 & A.4.7.8)
 - The span stability and warm-up time test can be conducted with either the complete LC or, in the case that this is not possible, with the analogue part of the electronics using a simulator (refer to WELMEC 2.1 "Guide for testing of indicators").

B.1.2 Load cell series and families, selection of samples

It is usually the practice that test certificates are issued for a LC series under one type name. A LC series may consist of several families which have to be considered separately. In R60(2000), Annex B the definitions and rules for the selection of test samples out of a LC family are presented and have to be applied for making respective TCs.

B.2 Documentation

OIML R60(2000) contains only few information concerning the documentation to be submitted by the manufacturer. For a test certificate according to this guide, the following documentation shall be submitted to the Notified Body.

1. Product specification

- description
- data for checking compatibility of modules, see WELMEC 2 (Issue 3, 2000, No 11), eg by the aid of data sheets.

2. Drawings of

- the shape of the measuring element and the characteristic of conversion and the differences for different capacities
- housing
- in case of digital LCs, additional documentation is required according to the indicator guide (WELMEC document 2.1).

B.3. Test report

The test report shall be written as far as possible according to OIML R60(2000) Annex D. A summary of tests shall be given in the annex of the test certificate as suggested under B.4.2.

B.4 Test certificate

B.4.1 Layout of the test certificate

One test certificate for **one** load cell series (one or more load cell families) of **one** type name.

Label of the Notified Body

Test certificate

certificate number

issued by *Name of Notified Body, complete address*

notified body *number*

in accordance with - EN 45 501 (1992), paragraph 8.1 and 3.5.4 with fraction $p_{LC} = (0,3...0,8)$
- OIML R60 (Edition ...)

issued to *Name of applicant complete address*

in respect of LC *(construction principle, eg strain gauge, compression, ..)*

type *Type name of the LC (series)*

manufacturer *Name of manufacturer*

description and documentation The load cell (series) is described and documented - including a summary of tests - in the Annex which forms part of this test certificate and comprises .. pages.

characteristics ¹

((examples in double brackets))

Classification		<i>((C4))</i>			
Maximum number of LC verification intervals	n_{LC}	<i>((4000))</i>			
Maximum capacity in kg	E_{max}	<i>((30000))</i>			
Ratio of minimum LC verification interval	$Y = E_{max}/V_{min}$	<i>((24000))</i>			
Ratio of minimum dead load output return	$Z = E_{max}/(2*DR)$	<i>((7500))</i>			

addition. mark. *((-))* | temperature limits *((-10°C / +40°C))* | rated output $C = ((2,5))mV/V$ | input impedance $R_{LC} = ((4000)) \Omega$ | minimum dead load $E_{min} / E_{max} = ((0)) \%$ | safe overload $E_{lim} / E_{max} = ((150)) \%$

in case of revision:

This test certificate replaces the test certificate *No....* of *Date x*

City, date

Name and status of signatory

¹ The table with the essential technical data may, on the request of the manufacturer, be placed on the certificate itself. It may alternatively be given on the first page of the Annex (see B.4.2).

B.4.2 Contents of the annex of the TC

Annex to test certificate No. ... name and type of the LC

1 Technical data

The essential data for TACs are listed on the test certificate (on request of the manufacturer) alternatively, in the case of limited space on the certificate:

Table1: Essential technical data

Classification		((C4))		
Additional marking		((-))		
Maximum number of LC verification intervals	n_{LC}	((4000))		
Maximum capacity in kg	E_{max}	((30000))		kg
Minimum dead load, relative	E_{min} / E_{max}	((0))		%
Ratio to minimum LC verification interval	$Y = E_{max} / v_{min}$	((24000))		
Ratio to minimum dead load output return	$Z = E_{max} / (2 \cdot DR)$	((7500))		
rated output *)	C	((2,5))		mV/V *
maximum excitation voltage		((30))		V
input impedance (for strain gauge LCs **)	R_{LC}	((4000))		Ω
temperature rating		((-10 / +40))		$^{\circ}C$
safe overload, relative	E_{lim} / E_{max}	((150))		%

for LCs with digital output : *) number of counts for E_{max} , **) not required

2 Tests

The tests listed in the table(s) below have been carried out in accordance with OIML R60(2000) / EN45501 at the laboratory ..., as documented in the test report No. ...

Table2: Tests performed with LC: serial number .., Class , E_{max} , n_{LC} , Y, Z,

T e s t	R60 (2000)No.	approved	Institute (if more than one) eg notified body / manuf.
Temperature test and repeatability (at 20, -10, 40, and 20 $^{\circ}C$)	5.1.1, 5.4 / A.4.1	+	
Temperature effect on minimum dead load output (at 20, -10, 40, and 20 $^{\circ}C$)	5.5.1.3 / A.4.1.16	+	
Creep test (at 20, -10 and 40 $^{\circ}C$)	5.3.1 / A.4.2	+	
Minimum dead load output return (at 20, -10 and 40 $^{\circ}C$)	5.3.2 / A.4.3	+	
Barometric pressure effects at room temperature	5.5.2 / A.4.4	+	
Damp heat test, cyclic: CH-marked *) (or without marking) static: SH-marked *)	5.5.3.1 / A.4.5 5.5.3.2 / A.4.6	- +	
additionally for LCs equipped with electronics	6 / A.4.7	+	
Warm-up time	6.3.2 / A.4.7.2	+	
Power voltage variation	6.3.3, 6.3.4 / A.4.7.3	+	
Short time power reduction	6.3.5 / A.4.7.4	+	
Bursts	6.3.5 / A.4.7.5	+	
Electrostatic discharge	6.3.5 / A.4.7.6	+	
Electromagnetic susceptibility	6.3.5 / A.4.7.7	+	
Span stability test	6.3.6 / A.4.7.8	+	

* one of the two is necessary for free interchangeability
(For tests with further LC samples add further tables mentioning the tests performed)

- 3 Description of the load cell
- construction principle, and
 - drawing or photo, and
 - code of the type designation, and
 - sealing if necessary.

4 Documentation

The test results and the following drawings are kept at the Notified Body:

Principle drawing Nos. ... dimensions, ... load cell body, ... housing, sealing
Data sheet No. ... data, dimensions, load application

5 Further information

5.1 Validity of this test certificate

Manufacturing process, material and sealings of the produced load cells have to be in accordance with that of the tested patterns; essential changings are only allowed with the permission of the notified body.

in case of additions to an existing TC :

5.2 Scope of revision

The original test certificate of *date* has been extended by ...

6 Data sheet, dimensions and load transmissions if requested by the manufacturer

7 Drawings for sealing if necessary

B.4.3 Revision of existing TCs

In order to avoid unnecessary paper work for existing TCs for LCs which do not comply with the rules of both, Part A and Part B of this guide, the following general requirements are agreed:

- 1 Existing TCs need not be revised if all data (at least E_{max} , n_{LC} , v_{min} and C) necessary to fill in the form "Compatibility of Modules" (WELMEC 2, Issue 3, 2000) are available in the TC; other data may be supplied subsequently by the data sheet of the LC manufacturer.
- 2 If a p_{LC} factor is not mentioned explicitly, a factor $p_{LC} = 0,7$ will be assumed.
- 3 Existing TCs need not be revised or amended if barometric pressure tests (R60(2000), No.5.5.2) were subsequently performed on existing LCs. A declaration of the manufacturer (eg in the data sheet of the LC) or a written confirmation of a Notified Body is sufficient in that case.
- 4 A revision of / or amendment to an existing TC shall be issued if an NH marked LC has subsequently passed a humidity test, either according to EN 45501 or to R60(2000).
- 5 If the range of capacities or the metrological characteristics of an existing LC type is extended, the new requirements of this guide shall be applied for the additional tests and a revision of / or amendment to an existing TC shall be issued.

Revisions of this guide

Issue	Date	Significant changes
1	October 1997	Guide first issued.
2	August 2001	<p>Replacement of some references to R60 by references to R60 (1991) and R60 (2000).</p> <p>Changes to references to Part B in the Introduction.</p> <p>Numerous changes to Part B, mainly in its introduction and in Parts B.1.1 and B.1.2.</p> <p>Removal of the Annex C1 to C3.</p> <p>Addition of Drawing 11 in Table 3.</p> <p>Replacement of “uncritical” by “non-critical”.</p> <p>Addition of this Revisions section.</p>